

**zzHof – PROJECTS**  
**Illustrations**

---

**zzHofprojects.com**

**Copyright © 2012 by Z. Hof**

---

**Created in the United States by:**  
**Z. Hof**

---

**Illustrations**

---

**Note:** These illustrations are to illustrate construction methods and terms; however, Local naming conventions may vary depending on where the construction work is being done. But, many of the terms are recognized by construction workers throughout the United States and the World.

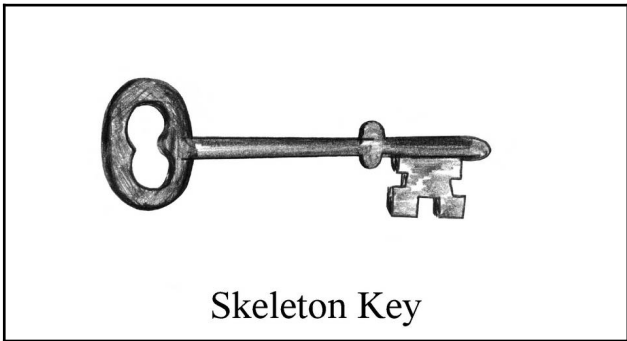
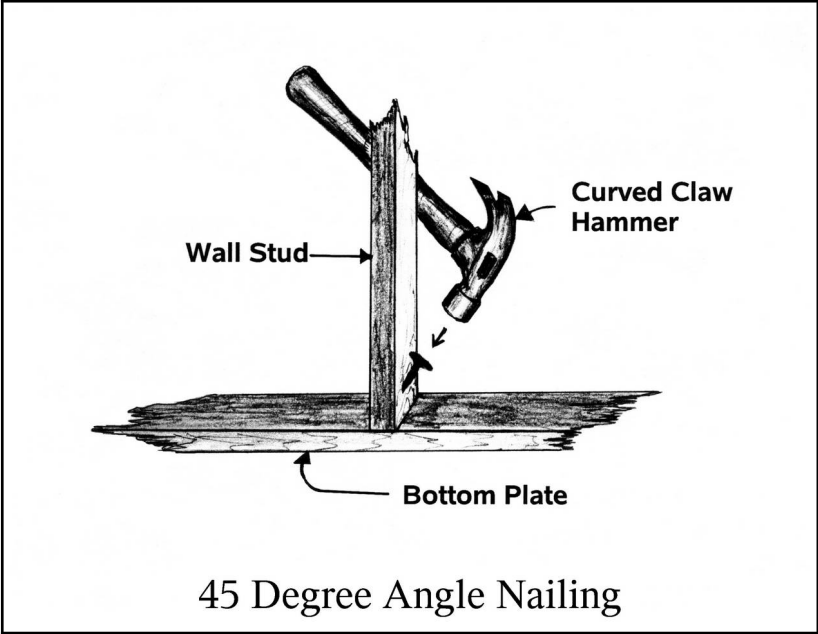

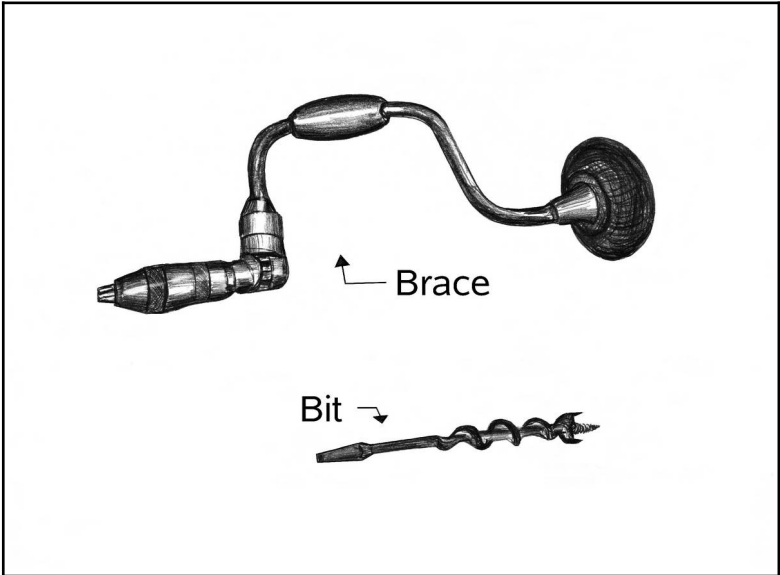
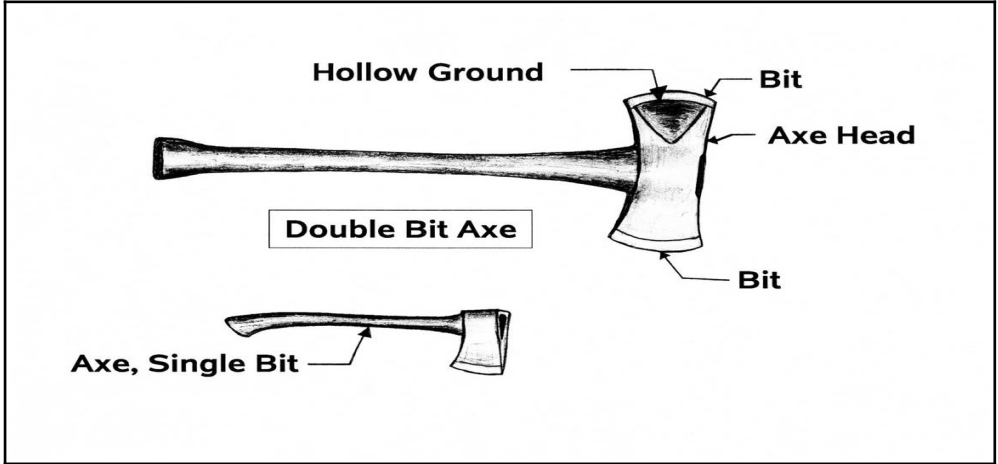

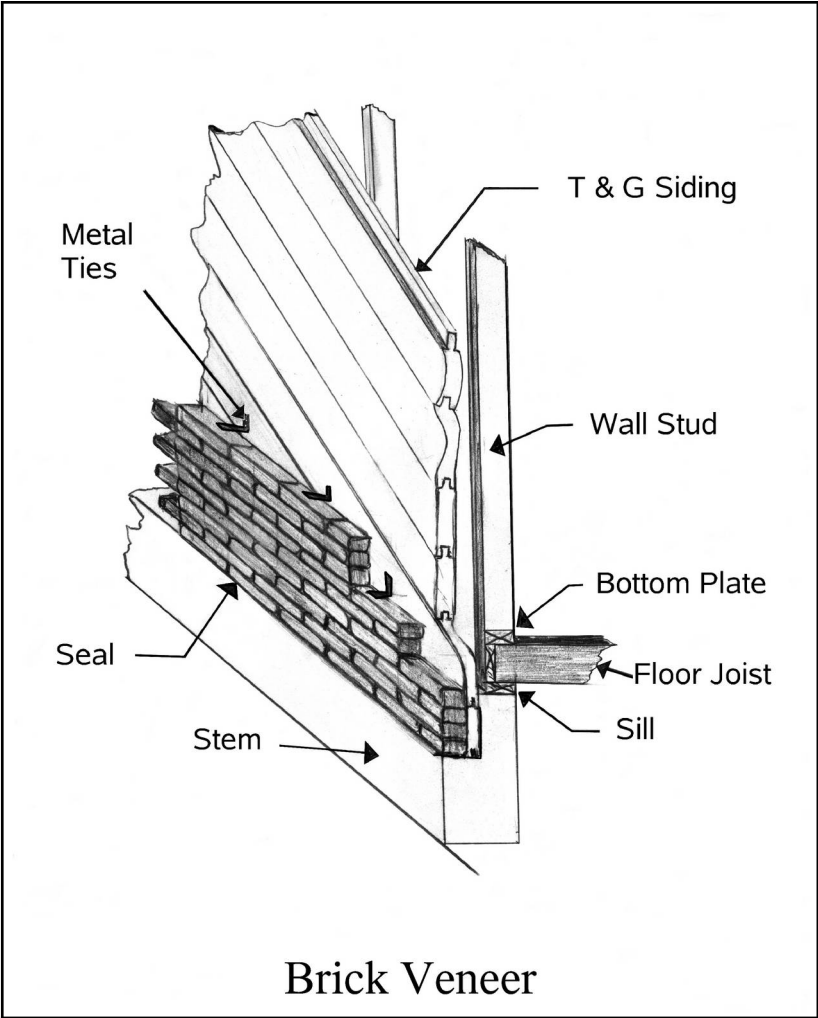

Notch  
For a  
Hand  
Saw

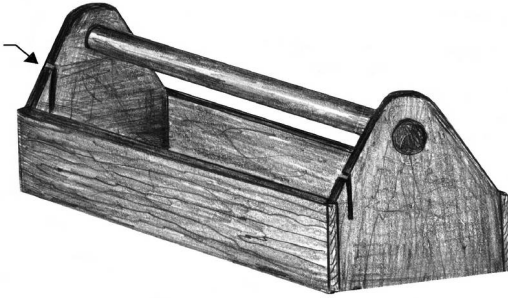

Pole Handle Tool Box

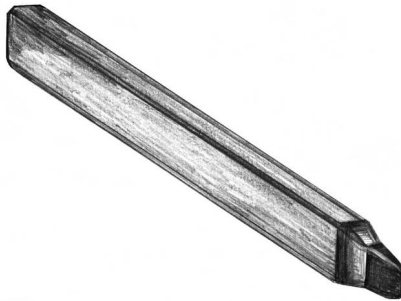

Carpenter Pencil

Feather  
Edged  
Casing



Beaded  
Casing



Colonial Casing

Door Casings

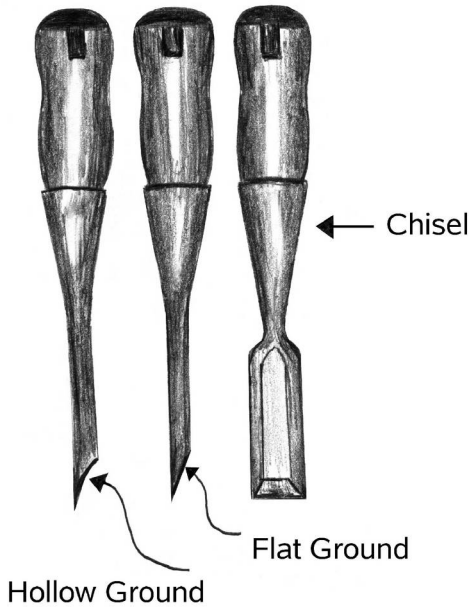

Chisels

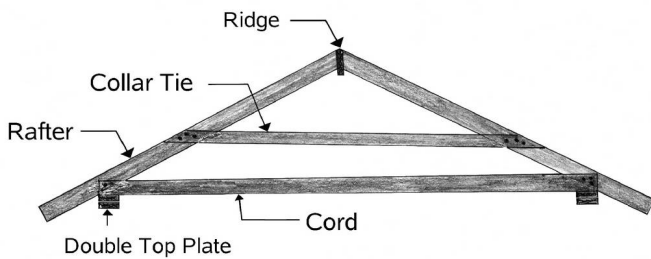

One Kind Of Conventional Framing

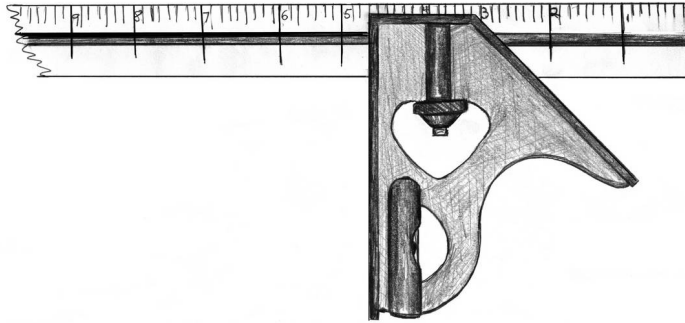

Combination Square

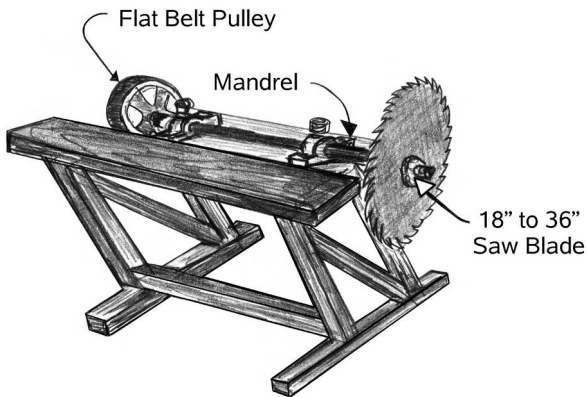

Cordwood Saw or Buzz Saw

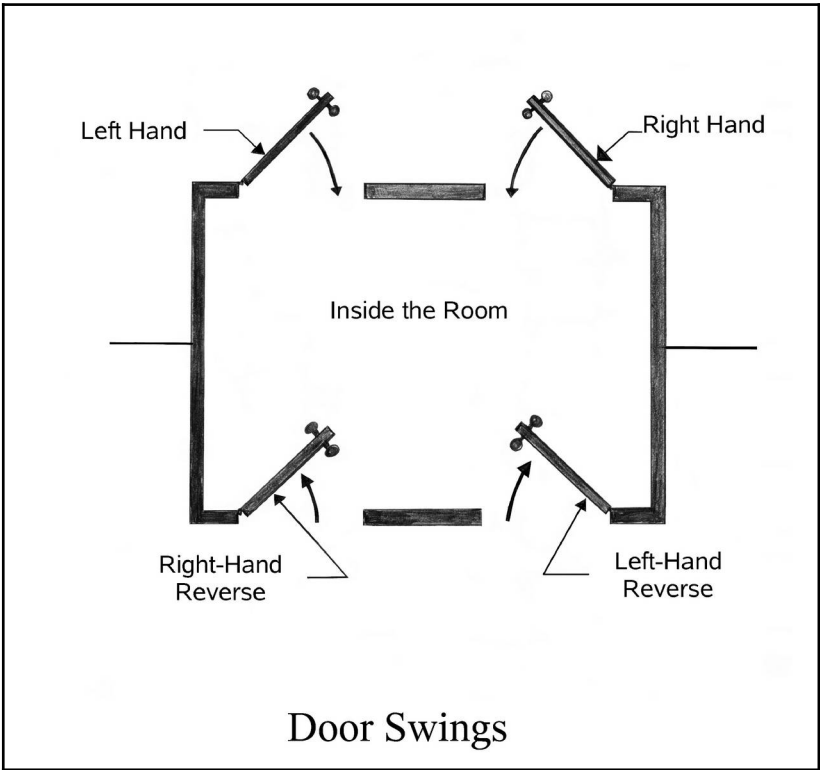
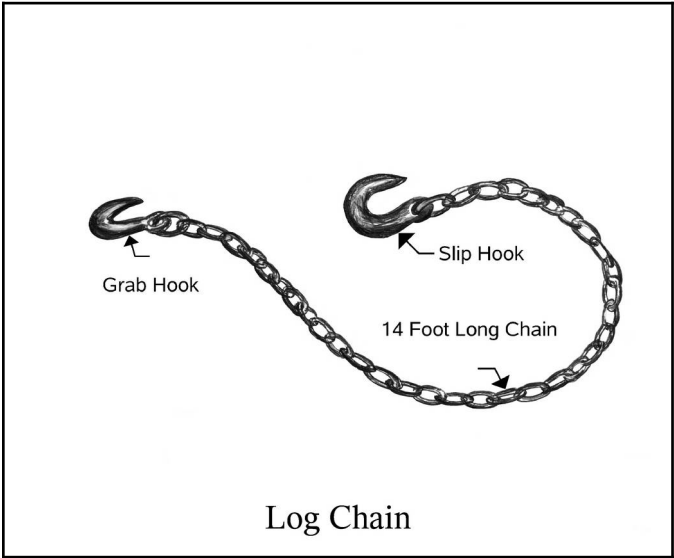

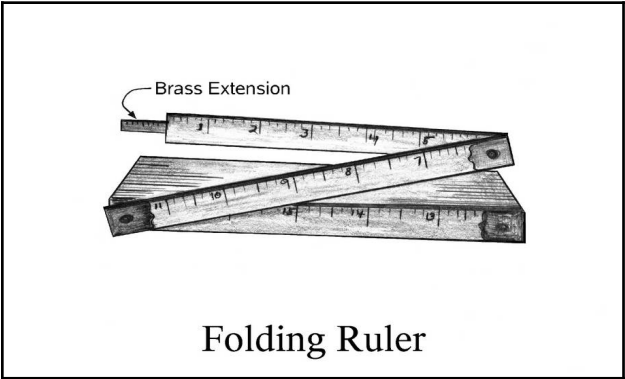

Folding Ruler

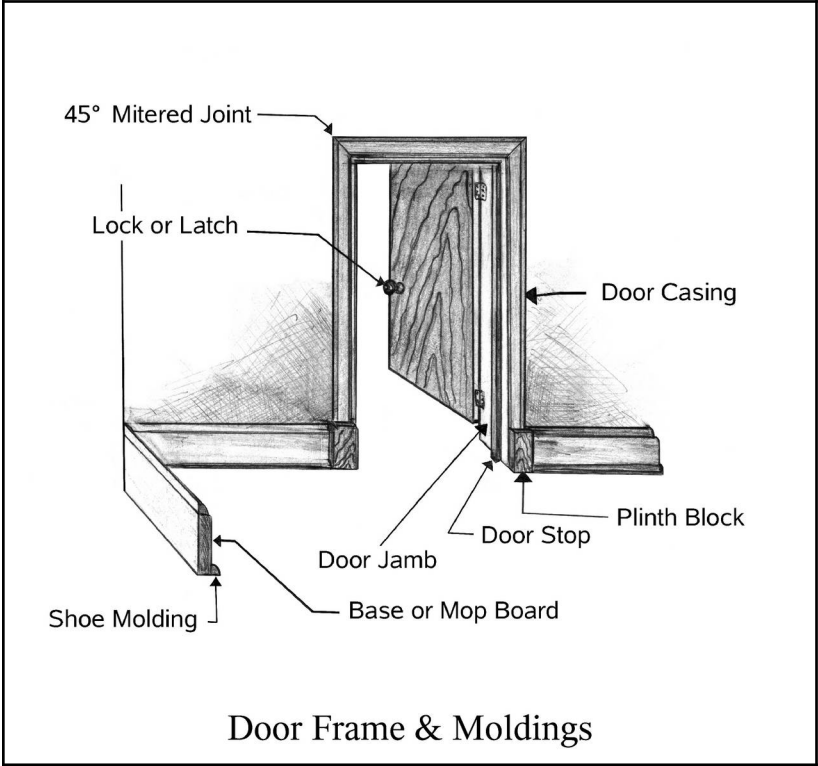

Door Frame & Moldings

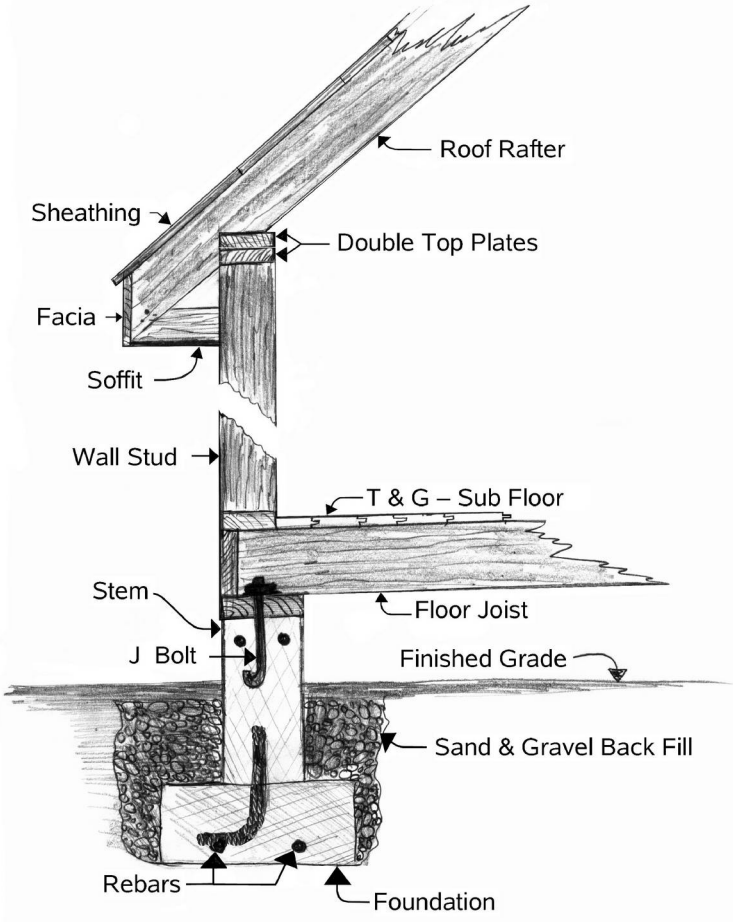

Foundation & Up

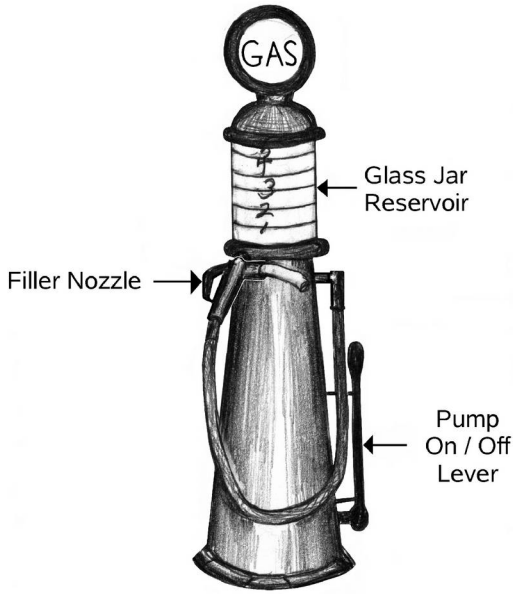

Glass Jar Gravity – Gas Pump

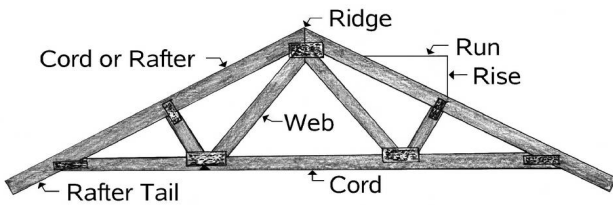

Roof Truss

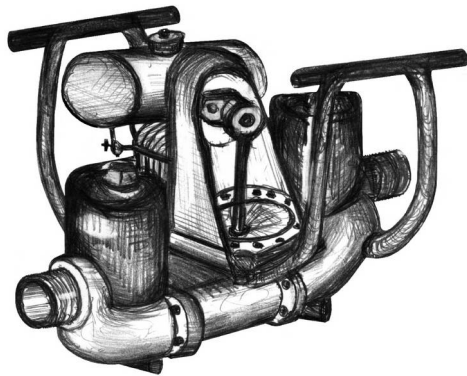

Diaphragm Pump

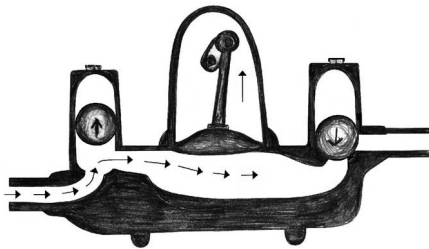

Diaphragm Pump - Intake Stroke

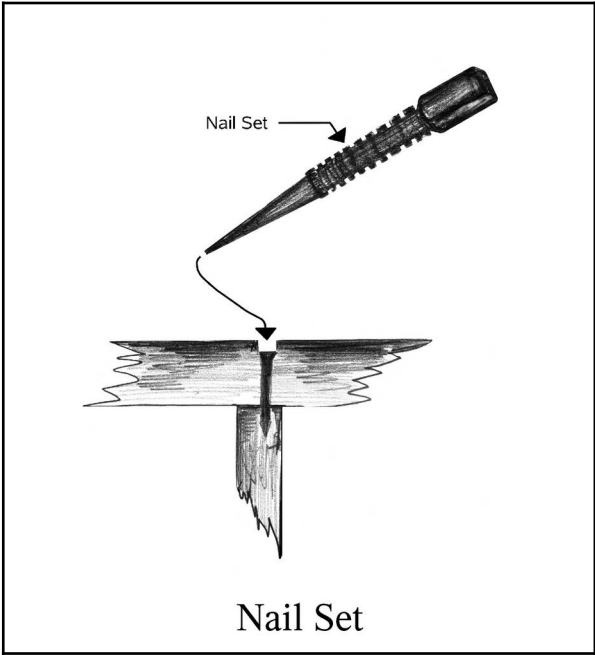
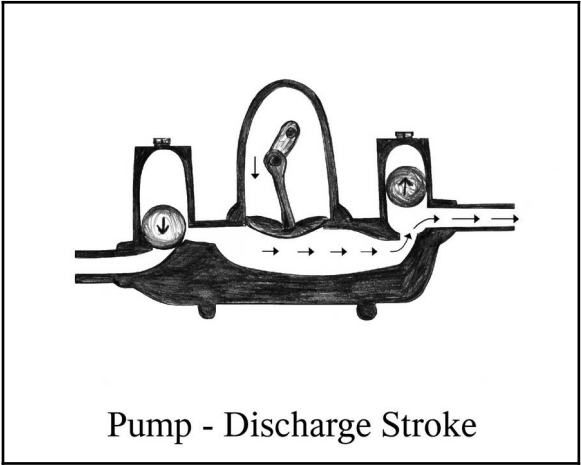

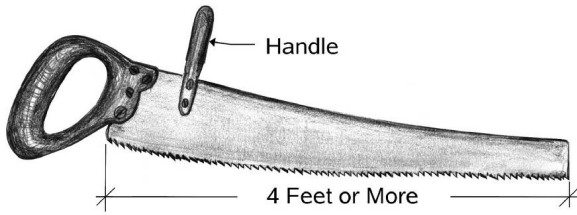

One Man Saw



Sledgehammer

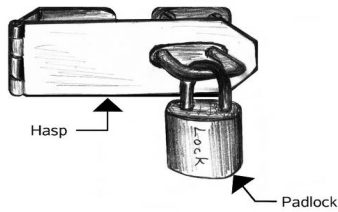

Hasp

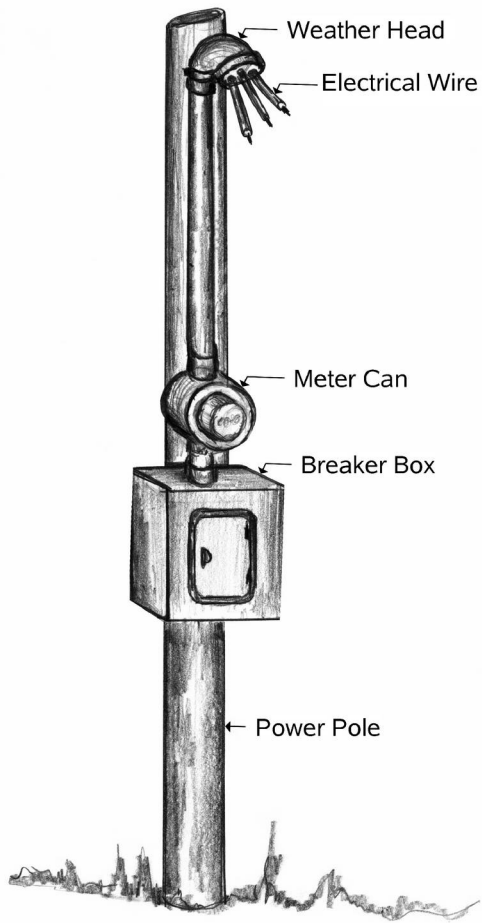

Temporary Power Pole

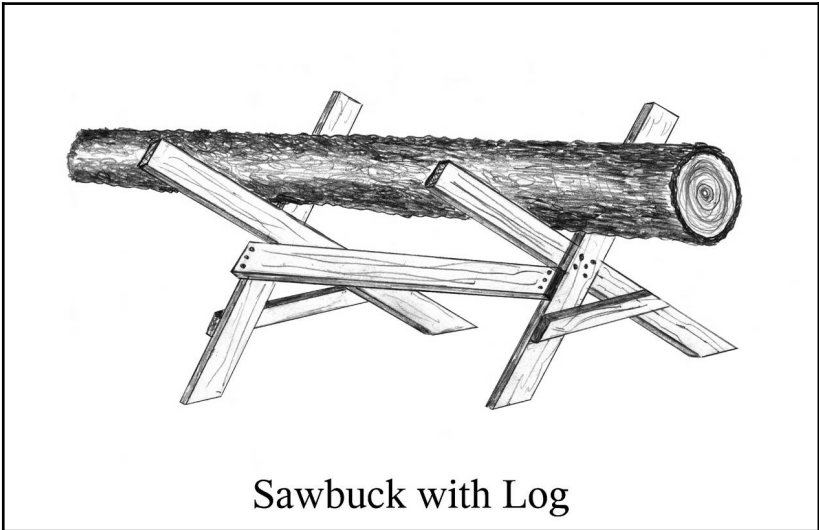
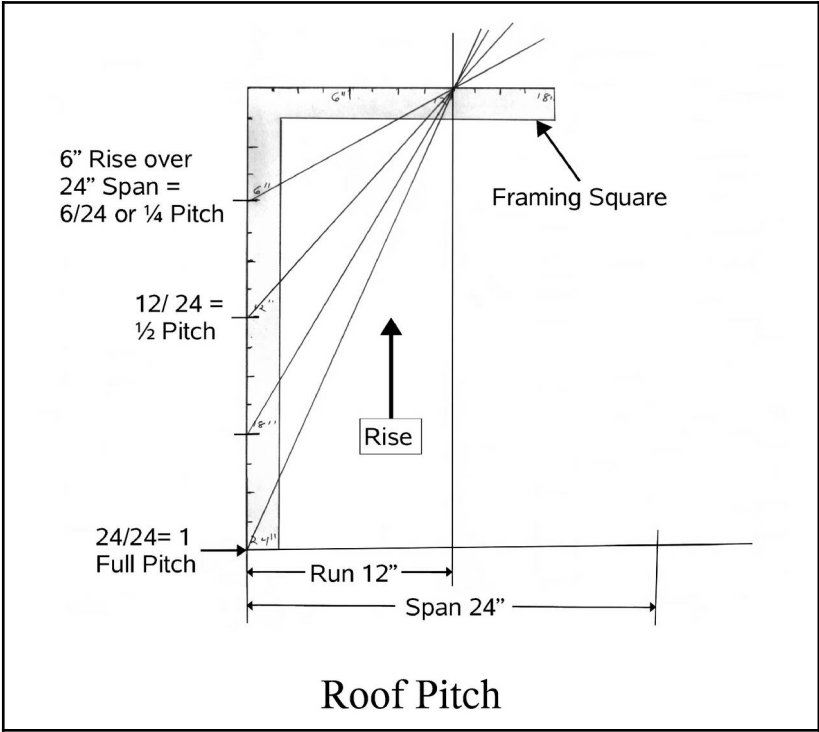

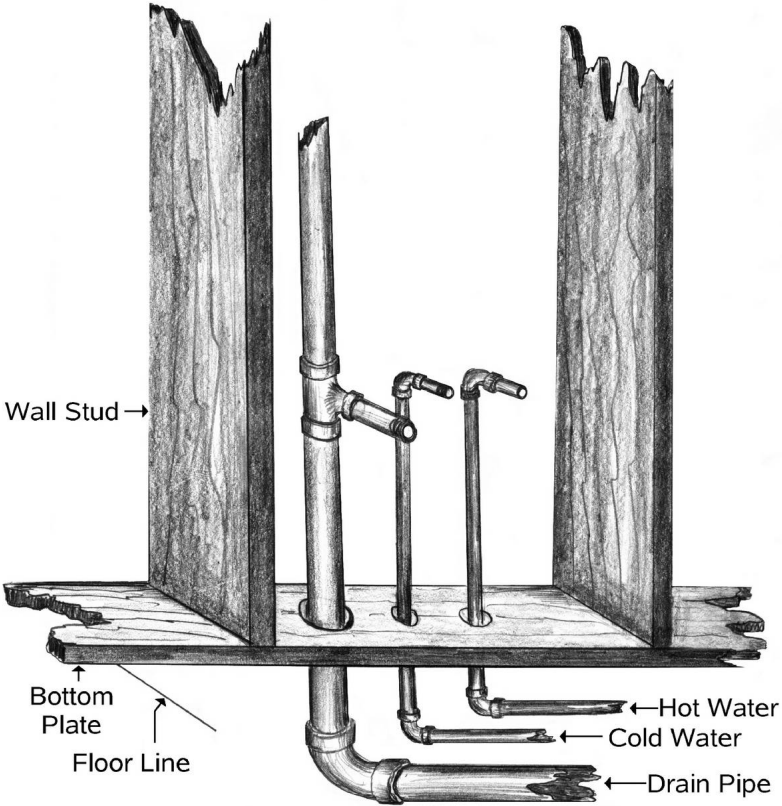

Rough-in Plumbing

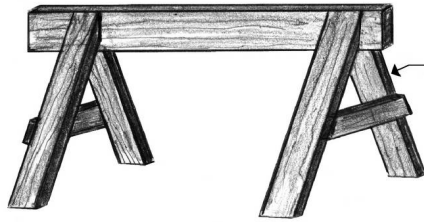

Strong Good  
for Framing

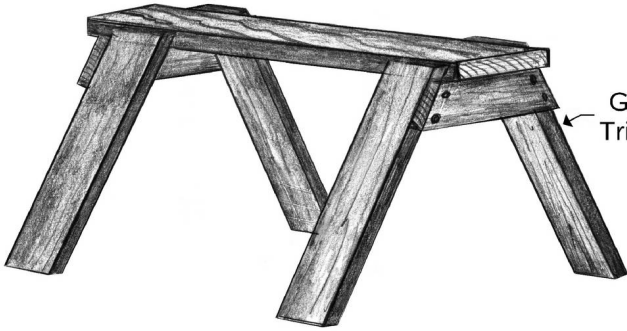

Good for  
Trim Work

## Sawhorses

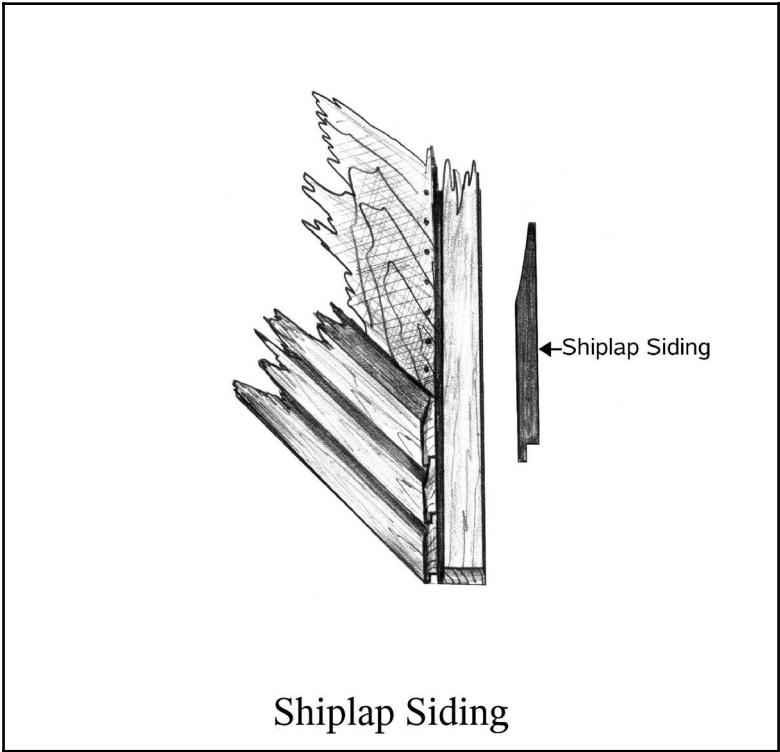

Shiplap Siding

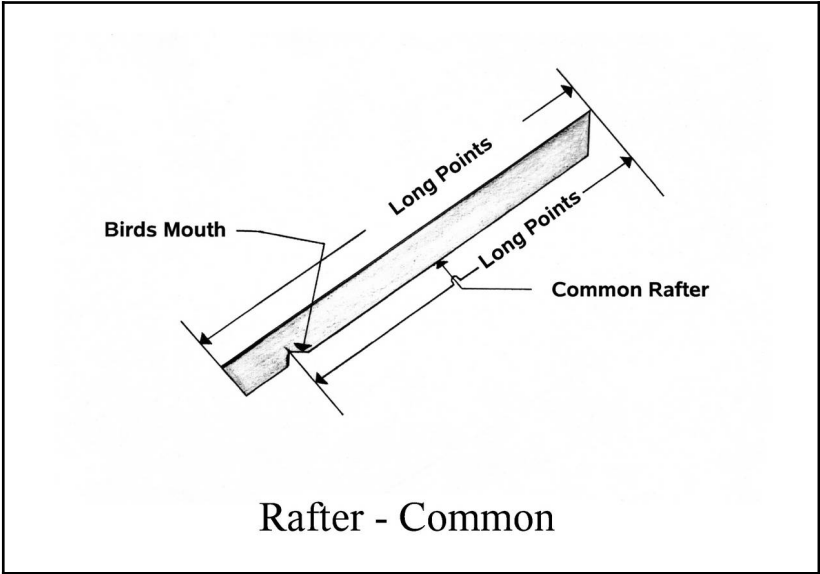

Rafter - Common

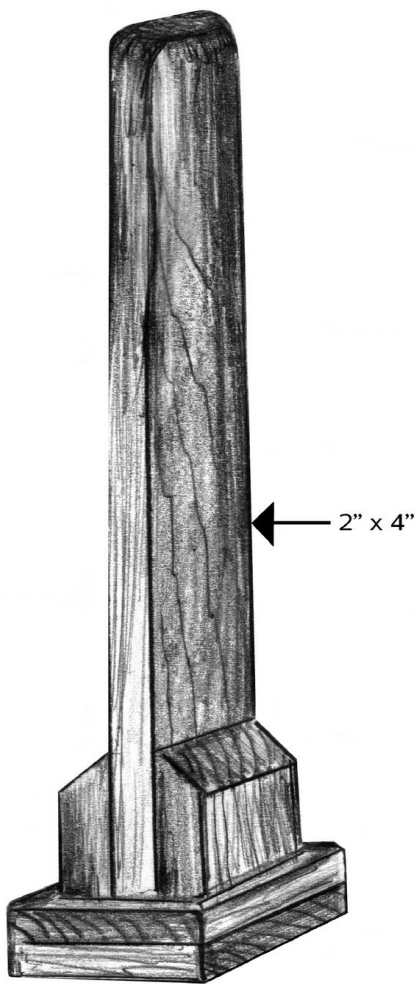

Homemade Tamp

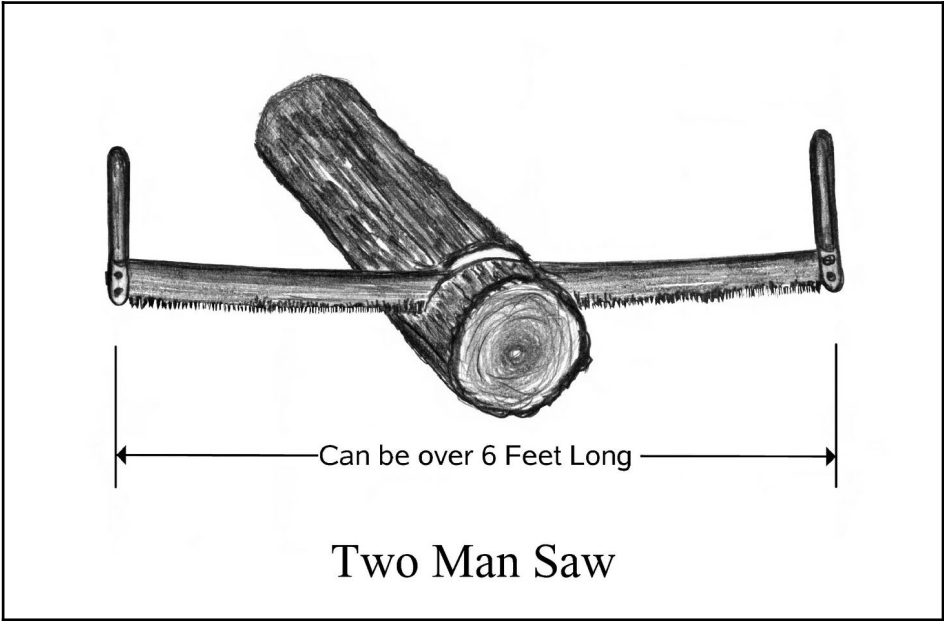
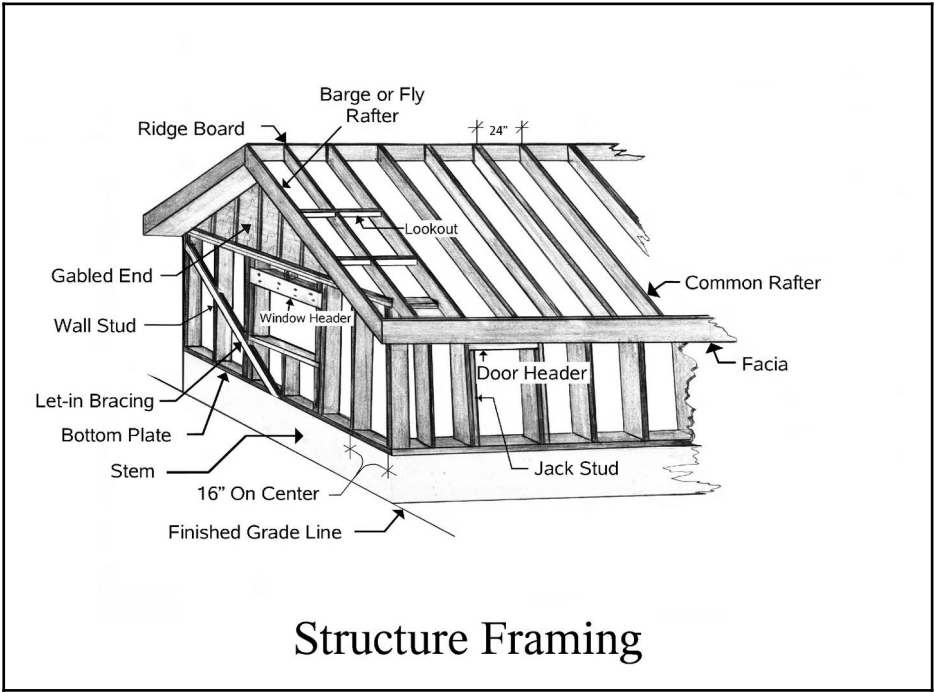

Wedge Driven is in with  
a Sledgehammer



Steel Wedge

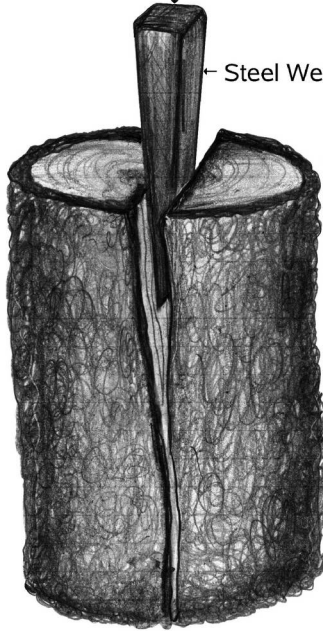

Steel Wedge